

2SK3262-01MR

FUJI POWER MOS-FET

N-CHANNEL SILICON POWER MOS-FET

■ Features

- High speed switching
- Low on-resistance
- No secondary breakdown
- Low driving power
- Avalanche-proof

■ Applications

- Switching regulators
- UPS (Uninterruptible Power Supply)
- DC-DC converters

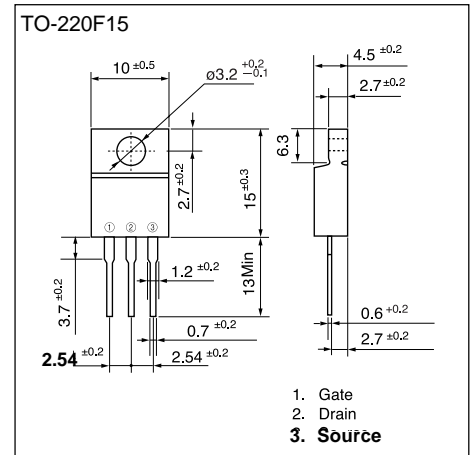

■ Maximum ratings and characteristic Absolute maximum ratings

● (Tc=25°C unless otherwise specified)

Item	Symbol	Rating	Unit	
Drain-source voltage	V _{DS}	200	V	
Continuous drain current	I _D	±20	A	
Pulsed drain current	I _{D(puls)}	±80	A	
Gate-source voltage	V _{GS}	±20	V	
Maximum Avalanche Energy	E _{AV*1}	355	mJ	
Max. power dissipation	T _a =25°C	P _D	2	W
	T _c =25°C	P _D	45	W
Operating and storage temperature range	T _{ch}	+150	°C	
	T _{stg}	-55 to +150	°C	

*1 L=1.6mH, V_{cc}=24V

■ Equivalent circuit schematic

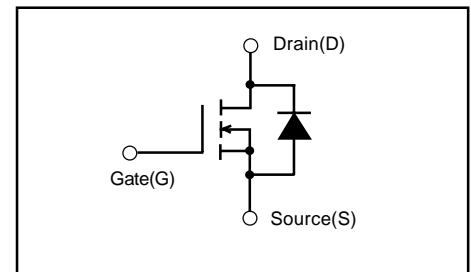

● Electrical characteristics (T_c =25°C unless otherwise specified)

Item	Symbol	Test Conditions	Min.	Typ.	Max.	Units
Drain-source breakdown voltage	V _{(BR)DSS}	I _D =1mA V _{GS} =0V	200			V
Gate threshold voltage	V _{GS(th)}	I _D =1mA V _{DS} =V _{GS}	1.0	1.5	2.0	V
Zero gate voltage drain current	I _{DSS}	V _{DS} =200V V _{GS} =0V	T _{ch} =25°C	10	500	μA
			T _{ch} =125°C	0.2	0.5	mA
Gate-source leakage current	I _{GSS}	V _{GS} =±20V V _{DS} =0V		10	100	nA
Drain-source on-state resistance	R _{DS(on)}	I _D =10A V _{GS} =4V		110	150	mΩ
		I _D =10A V _{GS} =10V		85	100	
Forward transconductance	g _{fs}	I _D =10A V _{DS} =25V	9.0	19.0		S
Input capacitance	C _{iss}	V _{DS} =25V		1700	2550	pF
Output capacitance	C _{oss}	V _{GS} =0V		290	435	
Reverse transfer capacitance	C _{rss}	f=1MHz		185	280	
Turn-on time t _{on}	td(on)	V _{CC} =100V I _D =20A V _{GS} =10V		10	15	ns
			t _r		45	
Turn-off time t _{off}	td(off)	R _G =10Ω		225	340	
			t _f		120	
Avalanche capability	I _{AV}	L=100μH T _{ch} =25°C	20			A
Diode forward on-voltage	V _{SD}	I _F =20A V _{GS} =0V T _{ch} =25°C		0.93	1.40	V
Reverse recovery time	t _{rr}	I _F =20A V _{GS} =0V		250		ns
Reverse recovery charge	Q _{rr}	-di/dt=100A/μs T _{ch} =25°C		2.90		μC

● Thermal characteristics

Item	Symbol	Test Conditions	Min.	Typ.	Max.	Units
Thermal resistance	R _{th(ch-c)}	channel to case			2.78	°C/W
	R _{th(ch-a)}	channel to ambient			62.5	°C/W

Characteristics

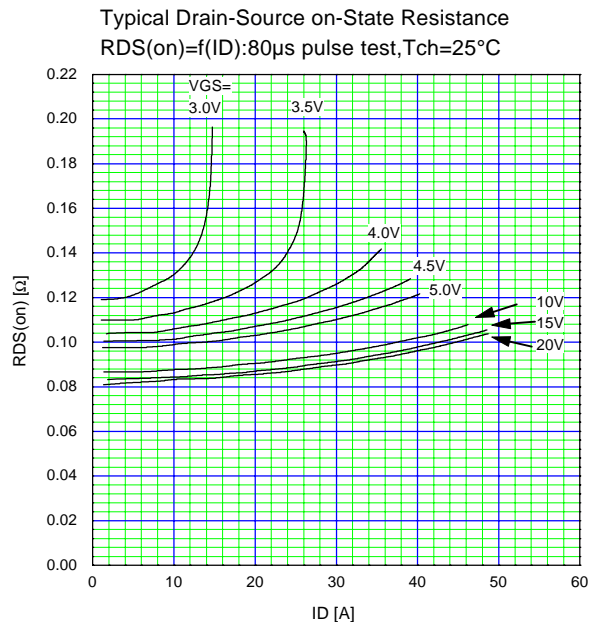
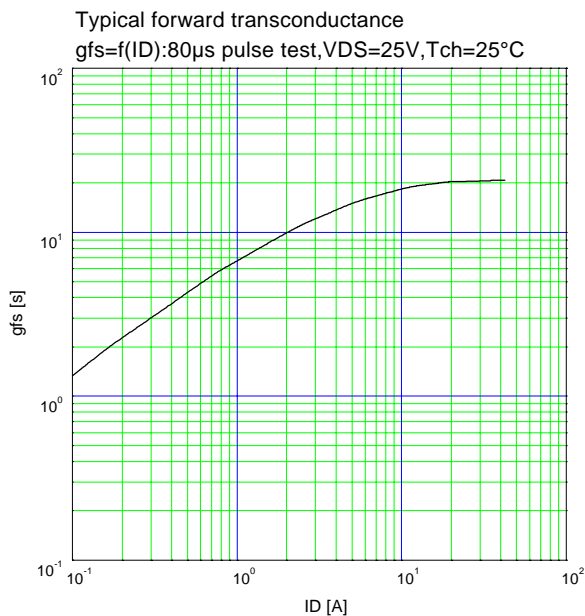
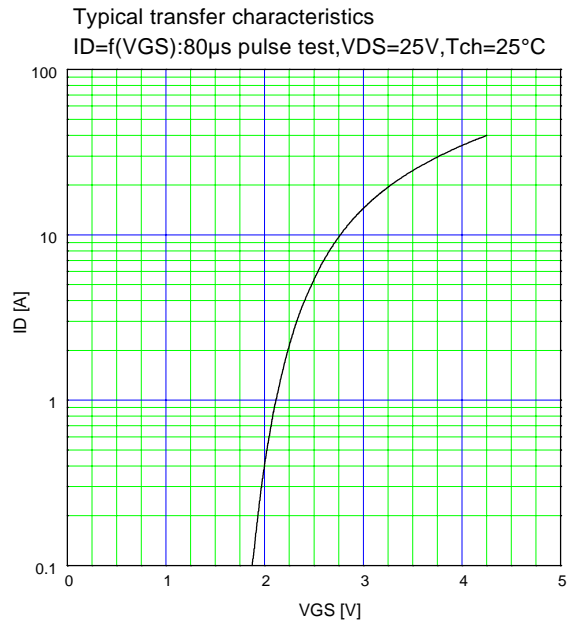
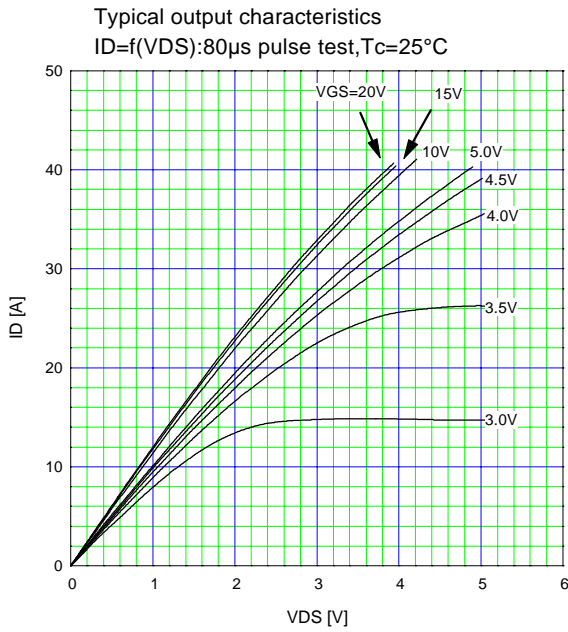
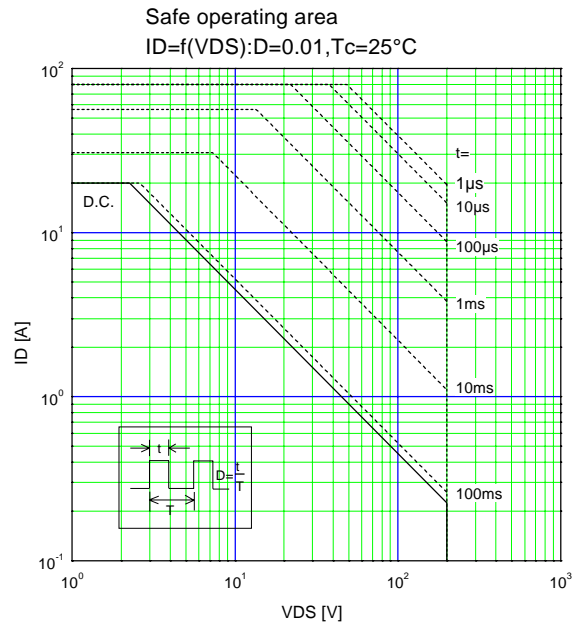
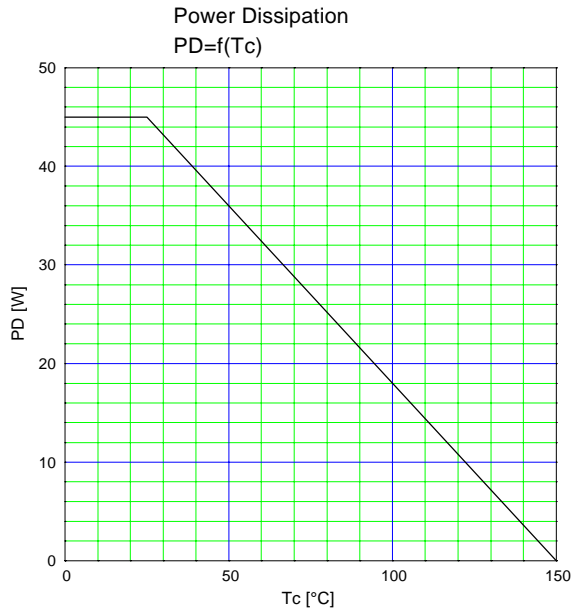

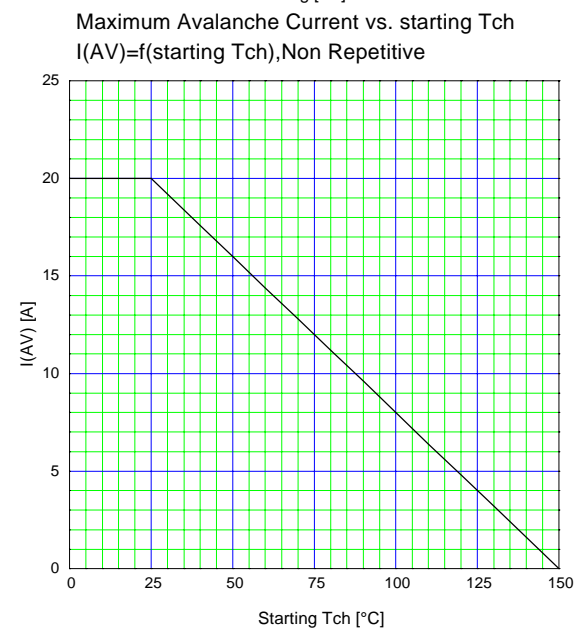
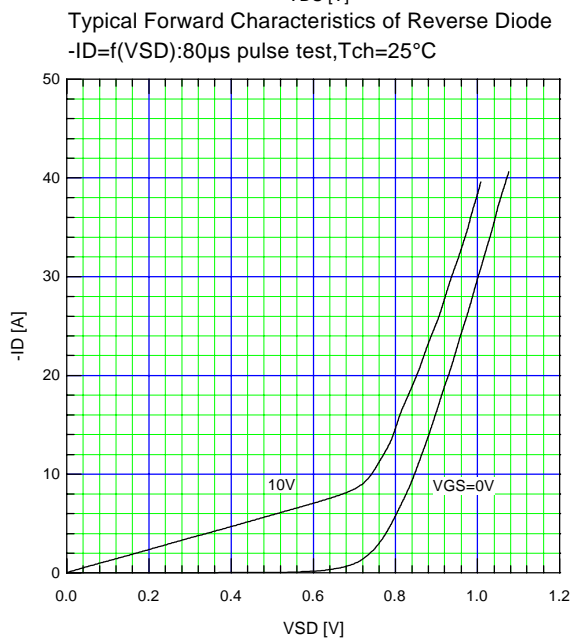
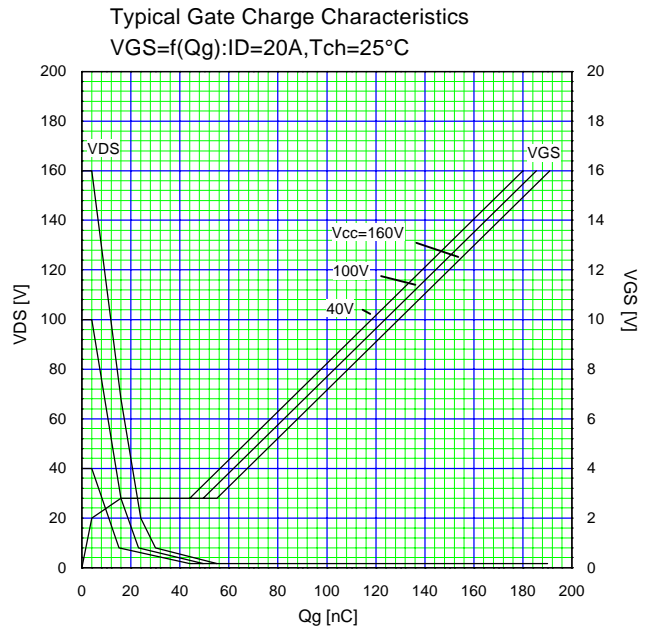
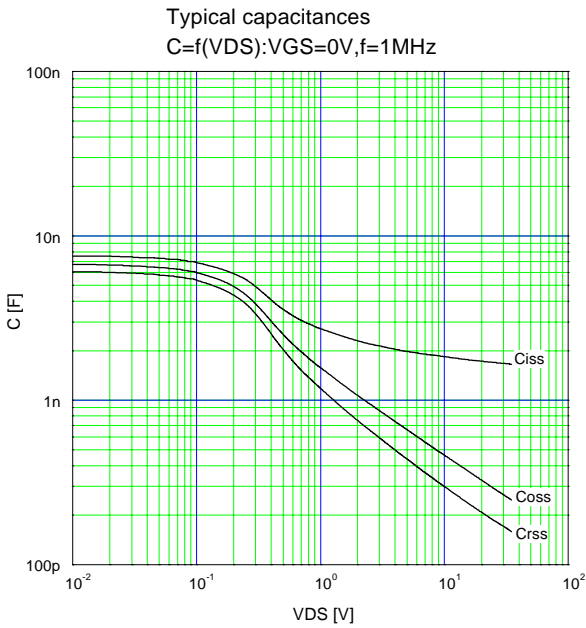
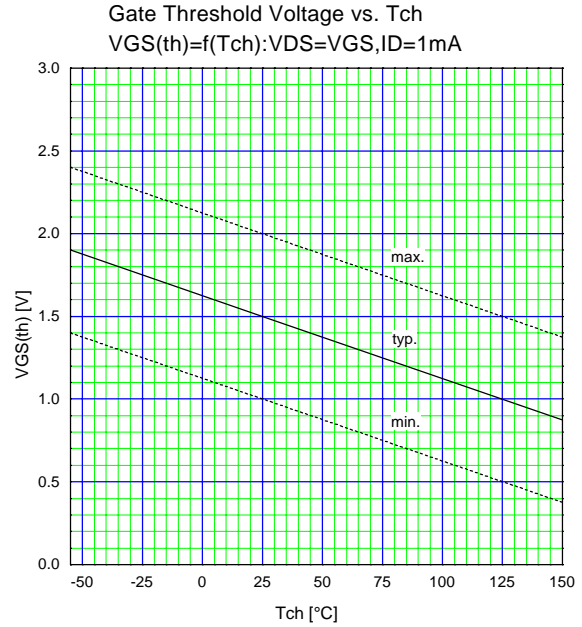
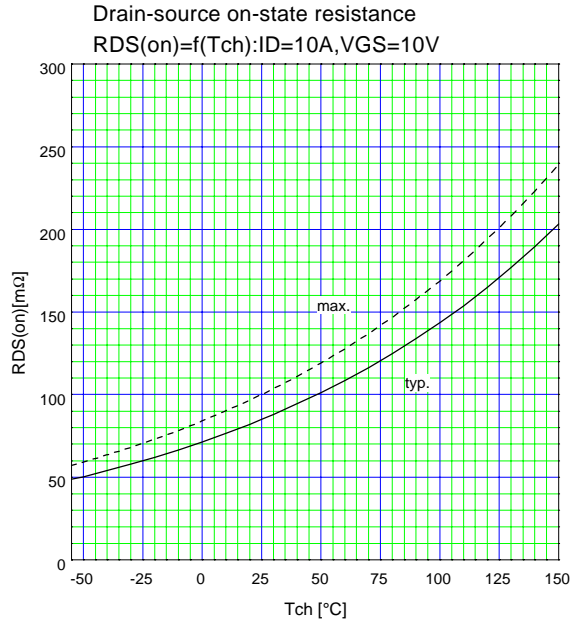

Maximum Avalanche energy vs. starting Tch
 $E_{as} = f(\text{starting Tch}) : V_{cc} = 24V_{AV}, I_{AV} \leq 20A, \text{Non-Repetitive}$

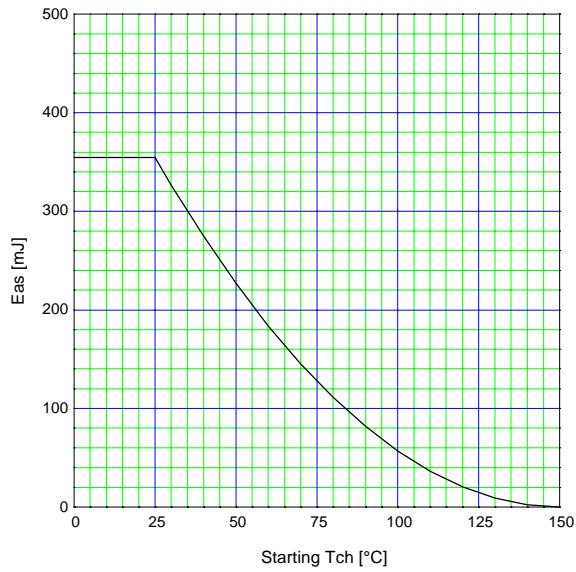

Transient Thermal Impedance
 $Z_{th(ch-c)} = f(t) : D = t/T$

